

micra
SEATING

EURO SEATING®
No limits to inspiration



No limits to inspiration.

EURO SEATING®

EURO SEATING INTERNATIONAL

Polígono Industrial El RAM, No. 11
C.P. 26280 Ezcaray
La Rioja, España

Tel. +34 941 427 450
941 427 452

euroseating@euroseating.com
www.euroseating.com

EURO SEATING® AMERICA

Carretera Tlajomulco, San Isidro Mazatepec No.615 F
CP 45640, Santa Cruz de las Flores,
Jalisco, México

Tel. (+52) 33 37 96 01 56
33 37 96 52 82
33 36 12 17 50

euro.seating@euroseating-america.com
www.euroseating-america.com

Seats for Cinema, Theater, Auditorium, Sport venues, Stadium, Telescopic bleacher, Conference room
Butacas para Cine, Teatro, Auditorio, Congresos, Estadios, Instalaciones Deportivas, Graderíos Telescópicos, Sala de Conferencias



End of life



MICRA SERIES

Versatile, comfortable and elegant seating line specially designed for places where space is of vital importance.

They make the most of the space without sacrificing comfort, with multiple installation possibilities, both fixed, mobile, in stairs, retractable or telescopic bleachers adaptable to both manual and automatic activation.

ITS NATURE MAKES IT SO VERSATILE ...

For the ability to offer different versions, depending on the space and the use to which they will go destined. Custom designs for each client with the highest quality and comfort.

Euro Seating America

SERIE MICRA

Línea de butacas versátil, confortable y elegante especialmente diseñadas para lugares donde el espacio resulta de vital importancia.

Permiten aprovechar al máximo el espacio sin renunciar al confort, con múltiples posibilidades de instalación, tanto fijas, móviles, en gradas, gradas retráctiles o telescópicas adaptables a mecanismos de abatimiento tanto manuales como automáticos.

SU NATURALEZA LA HACE ASÍ DE VERSÁTIL...

Por la capacidad para ofrecerle distintas versiones, en función del espacio y del uso al que vayan a ir destinadas. Diseños personalizados para cada cliente con la máxima calidad y confort.

Euro Seating America

PRESENT IN 128 COUNTRIES / PRESENTES EN 128 PAÍSES



PARTNERS EURO SEATING / SEDES EURO SEATING

CANADA · USA · MEXICO · DOMINICAN REPUBLIC · COSTA RICA · COLOMBIA · ECUADOR · CHILE · ARGENTINA · RUSSIA · UNITED KINGDOM · GERMANY · UKRAINE · KAZAKHSTAN · SPAIN · GREECE · TUNISIA · MOROCCO · SAUDI ARABIA · QATAR · ETHIOPIA · SINGAPORE · SOUTH AFRICA · AUSTRALIA

micra

IT THAT VERSATILE...
ASÍ DE VERSÁTIL...

Auditori Eduard Toldrà. Conservatori Municipal de Música.
Barcelona, España.



MICRA

MICRA COLORS

MICRA WOOD

MICRA TT



MICRA 500

MICRA 500 ARM

MICRA 100 ARM

MICRA PL



MICRA TEK -
MICRA TEK PAD

MICRA TEK TT

MICRA TEK 500
MICRA TEK PAD 500

MICRA TEK 500 ARM
MICRA TEK PAD 500 ARM



MICRA FG

MICRA TEK FG
MICRA TEK PAD FG

MICRA FLEXING

MICRA TEK FLEXING
MICRA TEK PAD FLEXING



Lenin School. Moscú, Rusia.



 MICRA



 MICRA COLORS



· Wide range of colors to choose by color on demand
· Amplia gama de colores a elegir por color a la carta

EUROSEATING Reserves the right to modify the seat specifications without notice. / EUROSEATING Se reserva el derecho de modificar las características sin previo aviso.

EUROSEATING Reserves the right to modify the seat specifications without notice. / EUROSEATING Se reserva el derecho de modificar las características sin previo aviso.

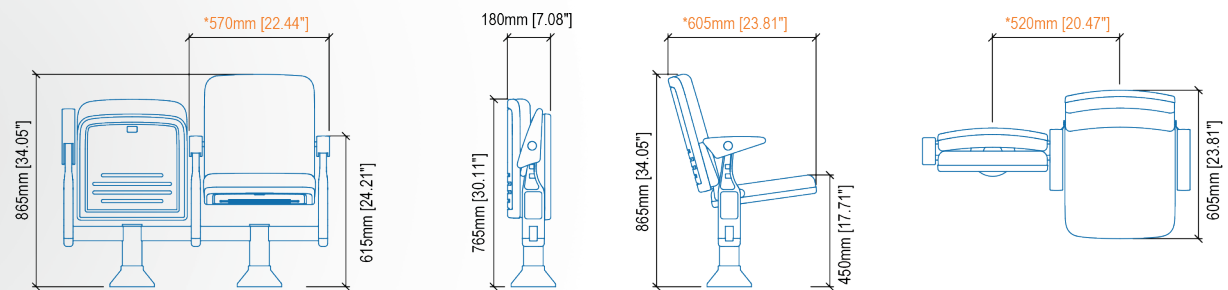

*Standard measure, may vary according to project. *Medida standard, puede variar según proyecto.

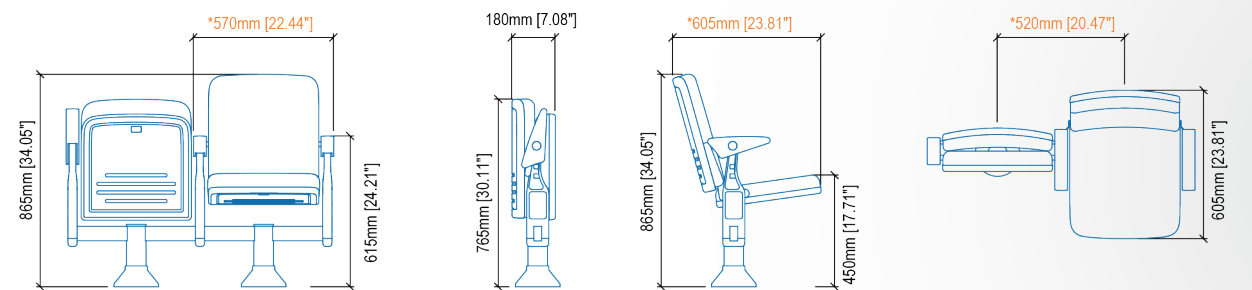

*Standard measure, may vary according to project. *Medida standard, puede variar según proyecto.



MICRA WOOD



MICRA TT

EUROSEATING Reserves the right to modify the seat specifications without notice. / EUROSEATING Se reserva el derecho de modificar las características sin previo aviso.

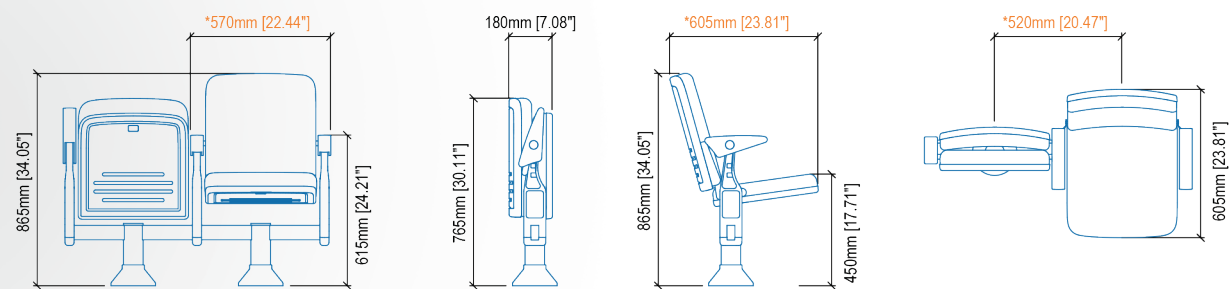

*Standard measure, may vary according to project. *Medida standard, puede variar según proyecto.

EUROSEATING Reserves the right to modify the seat specifications without notice. / EUROSEATING Se reserva el derecho de modificar las características sin previo aviso.

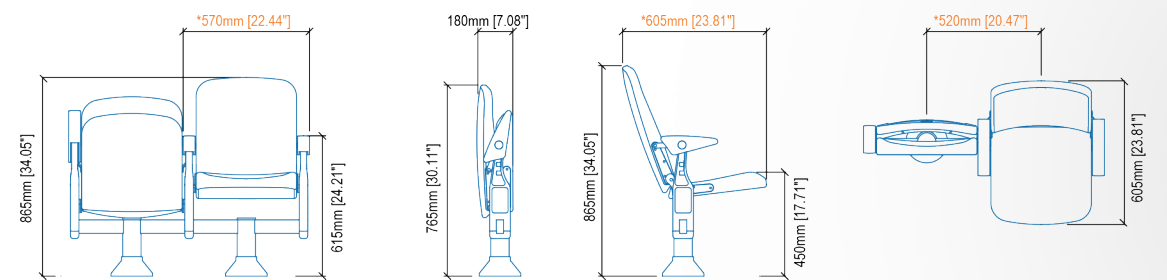

*Standard measure, may vary according to project. *Medida standard, puede variar según proyecto.

Teatro Fine Arts, American School, CDMX, México.





 MICRA TEK - MICRA TEK PAD



 MICRA TEK TT

EUROSEATING Reserves the right to modify the seat specifications without notice. / EUROSEATING Se reserva el derecho de modificar las características sin previo aviso.

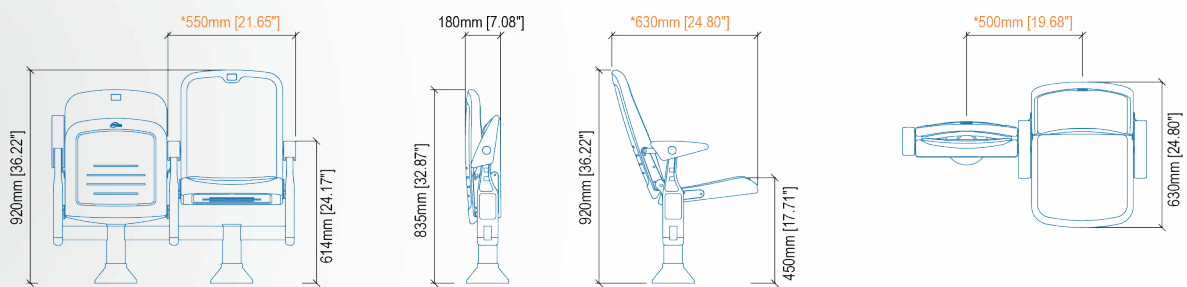

*Standard measure, may vary according to project. *Medida standard, puede variar segun proyecto.

EUROSEATING Reserves the right to modify the seat specifications without notice. / EUROSEATING Se reserva el derecho de modificar las características sin previo aviso.

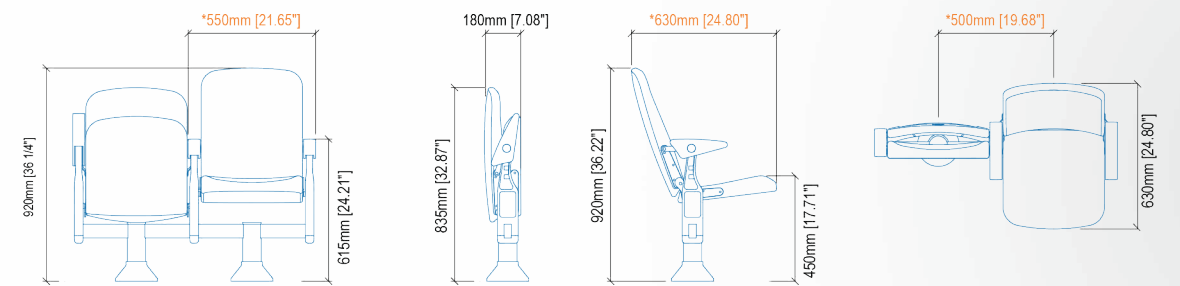

*Standard measure, may vary according to project. *Medida standard, puede variar segun proyecto.



 **MICRA TEK SG -
MICRA TEK PAD SG**



 **MICRA TEK ARM SG -
MICRA TEK ARM PAD SG**

EUROSEATING Reserves the right to modify the seat specifications without notice. / EUROSEATING Se reserva el derecho de modificar las características sin previo aviso.

EUROSEATING Reserves the right to modify the seat specifications without notice. / EUROSEATING Se reserva el derecho de modificar las características sin previo aviso.

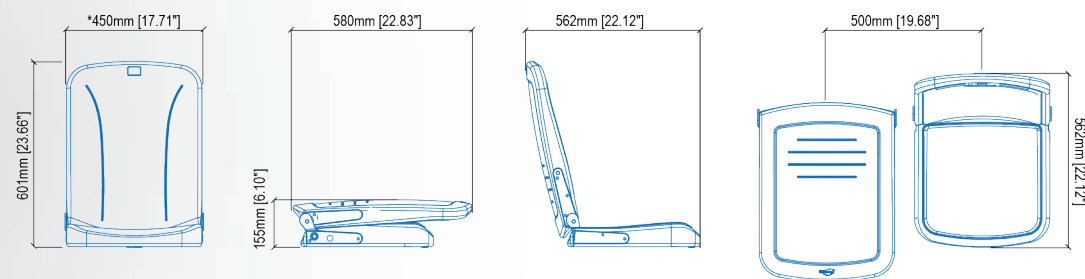

*Standard measure, may vary according to project. *Medida standard, puede variar según proyecto.

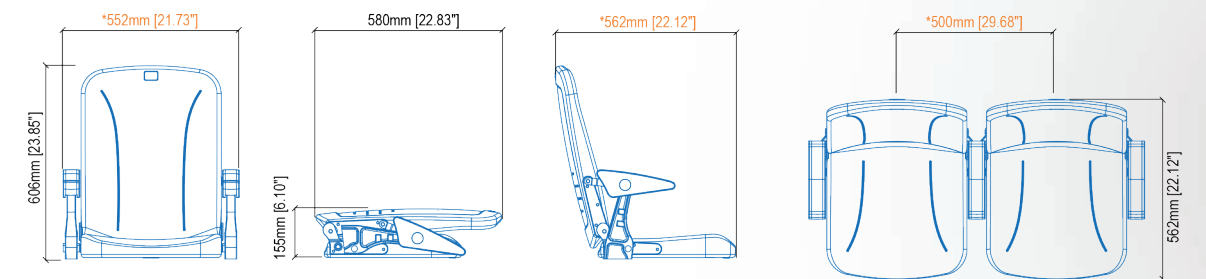

*Standard measure, may vary according to project. *Medida standard, puede variar según proyecto.

Arena Laval, Montreal, Canada.





 MICRA 500



 MICRA 500 ARM

EUROSEATING Reserves the right to modify the seat specifications without notice. / EUROSEATING Se reserva el derecho de modificar las características sin previo aviso.

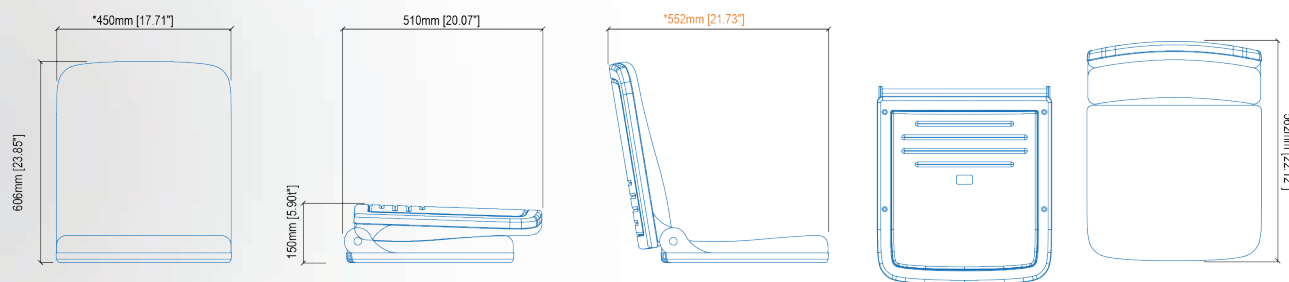

*Standard measure, may vary according to project. *Medida standard, puede variar segun proyecto.

EUROSEATING Reserves the right to modify the seat specifications without notice. / EUROSEATING Se reserva el derecho de modificar las características sin previo aviso.

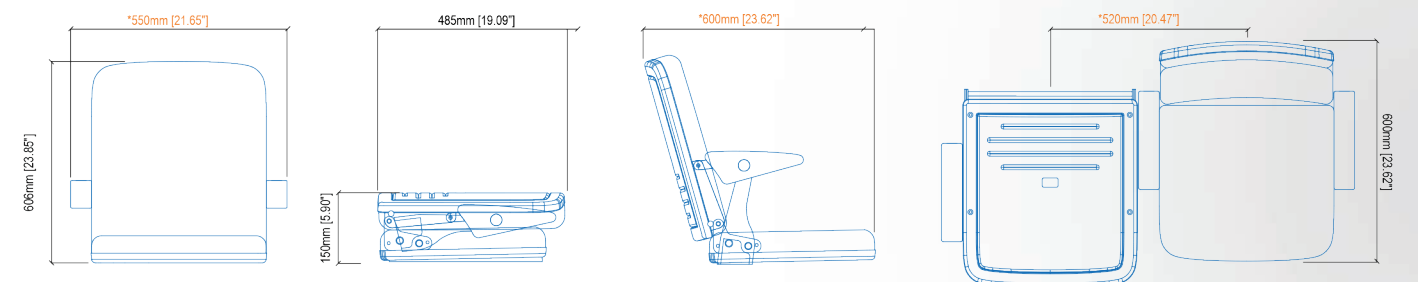

*Standard measure, may vary according to project. *Medida standard, puede variar segun proyecto.



 **MICRA 100 ARM**



 **MICRA PL**

EUROSEATING Reserves the right to modify the seat specifications without notice. / EUROSEATING Se reserva el derecho de modificar las características sin previo aviso.

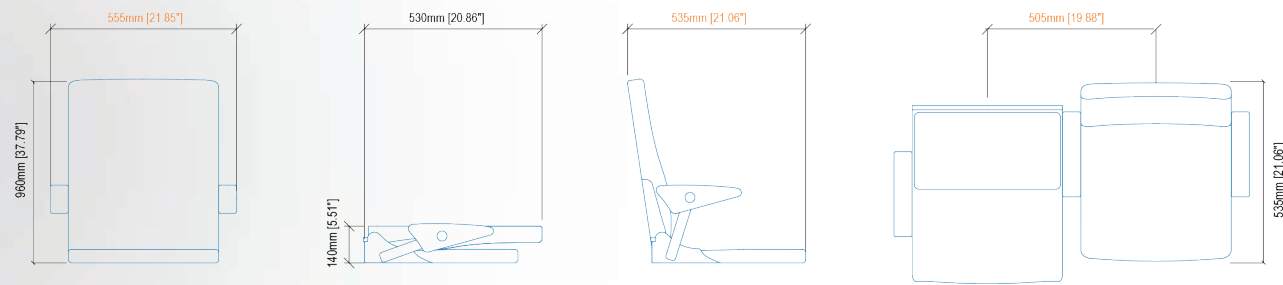

*Standard measure, may vary according to project. *Medida standard, puede variar según proyecto.

EUROSEATING Reserves the right to modify the seat specifications without notice. / EUROSEATING Se reserva el derecho de modificar las características sin previo aviso.

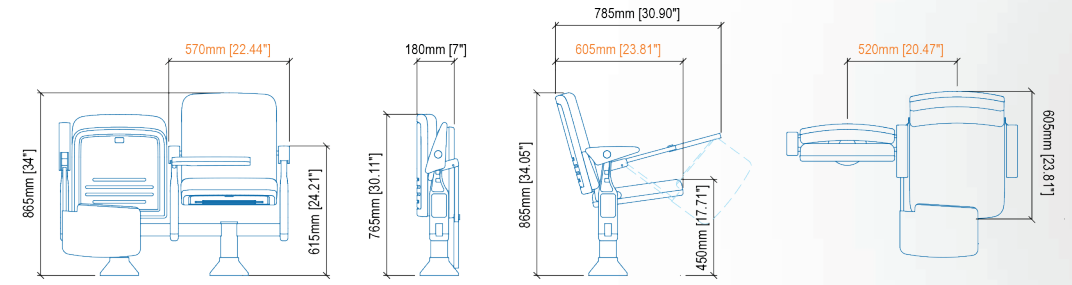

*Standard measure, may vary according to project. *Medida standard, puede variar según proyecto.

Estadio Santiago Bernabéu. Madrid, España.

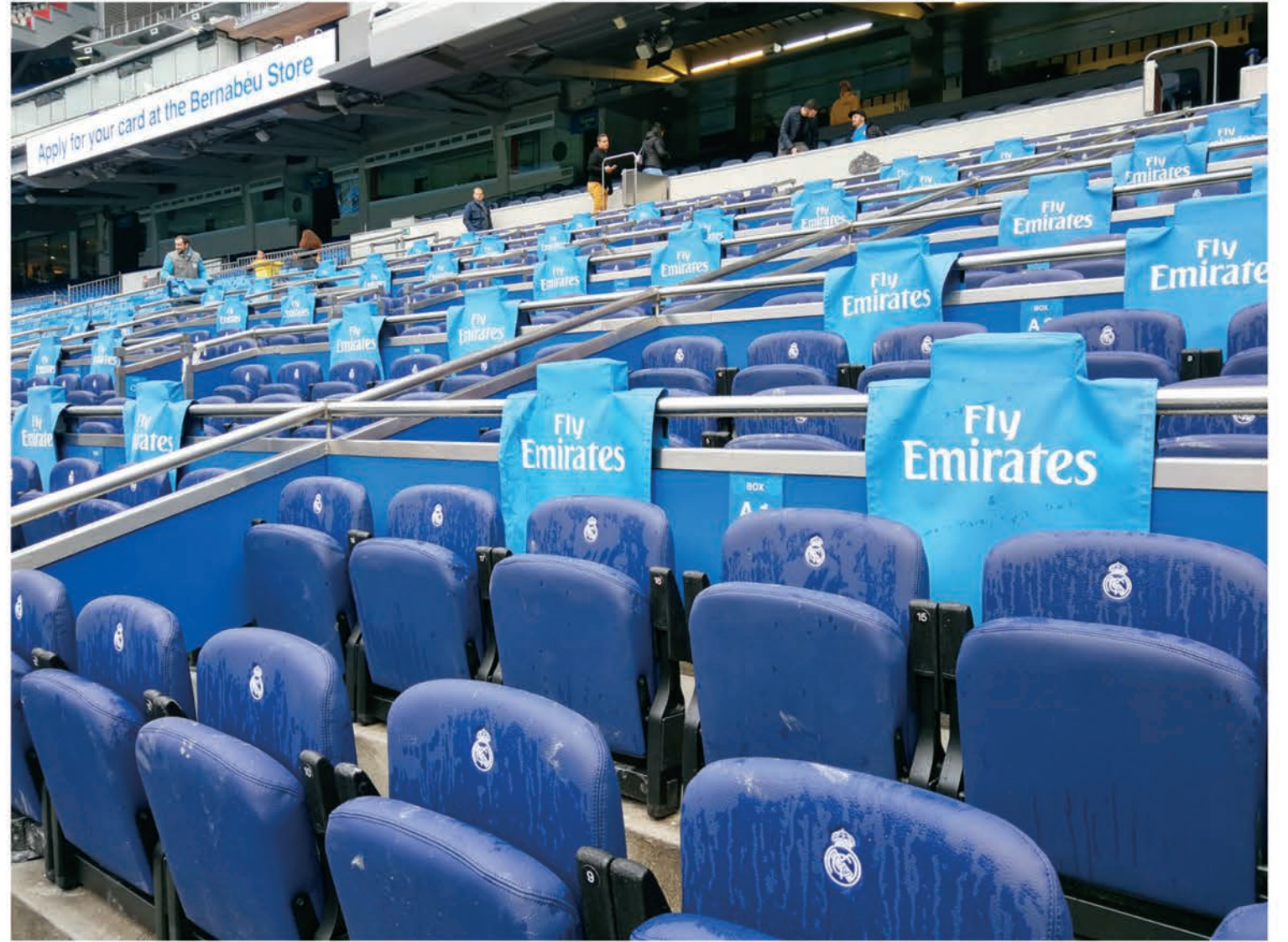



 MICRA FG



 MICRA TEK FG - MICRA TEK PAD FG

EUROSEATING Reserves the right to modify the seat specifications without notice. / EUROSEATING Se reserva el derecho de modificar las características sin previo aviso.

EUROSEATING Reserves the right to modify the seat specifications without notice. / EUROSEATING Se reserva el derecho de modificar las características sin previo aviso.

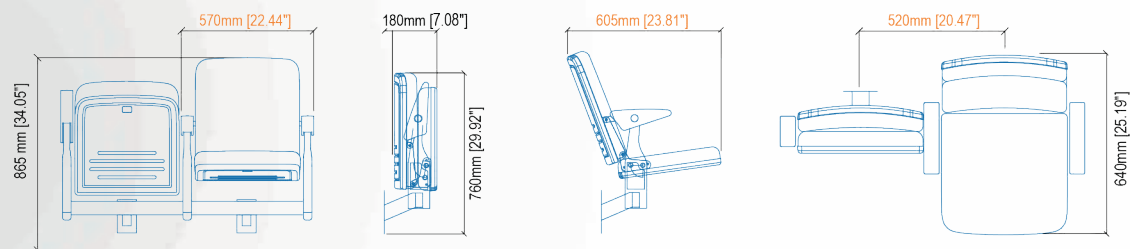

*Standard measure, may vary according to project. *Medida standard, puede variar según proyecto.

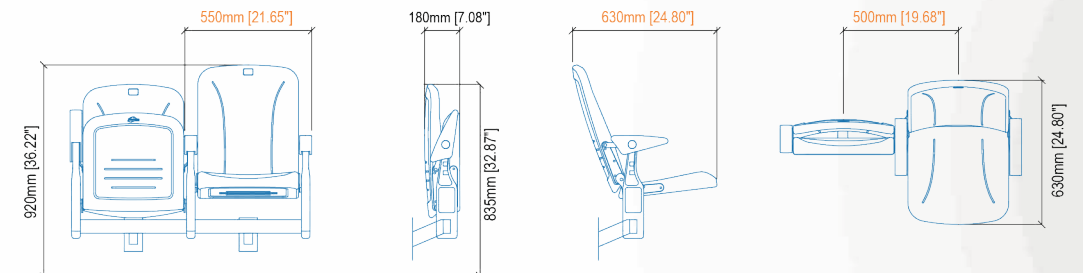

*Standard measure, may vary according to project. *Medida standard, puede variar según proyecto.



 **MICRA FLEXING**



 **MICRA TEK FLEXING - MICRA TEK PAD FLEXING**

EUROSEATING Reserves the right to modify the seat specifications without notice. / EUROSEATING Se reserva el derecho de modificar las características sin previo aviso.

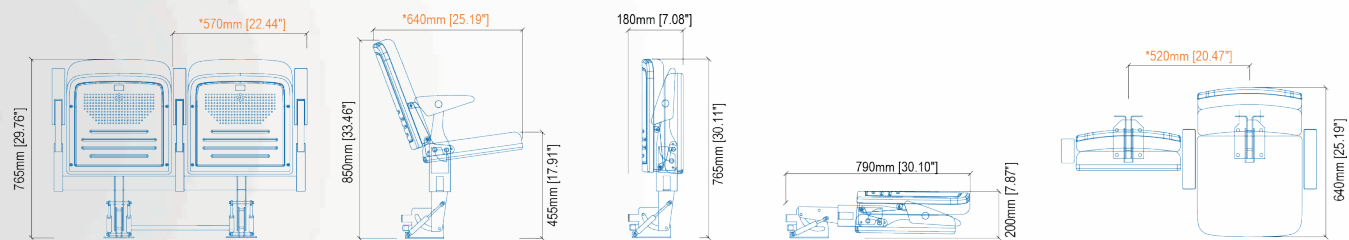

*Standard measure, may vary according to project. *Medida standard, puede variar según proyecto.

EUROSEATING Reserves the right to modify the seat specifications without notice. / EUROSEATING Se reserva el derecho de modificar las características sin previo aviso.

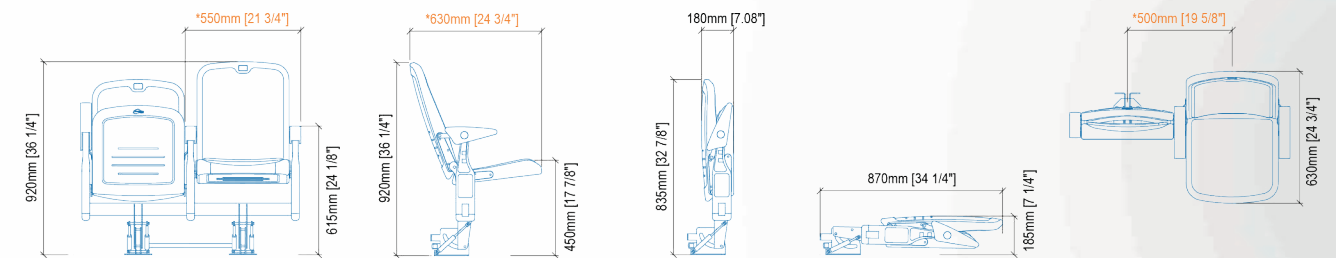

*Standard measure, may vary according to project. *Medida standard, puede variar según proyecto.

Centro de Congresos. Carcassonne, Francia.

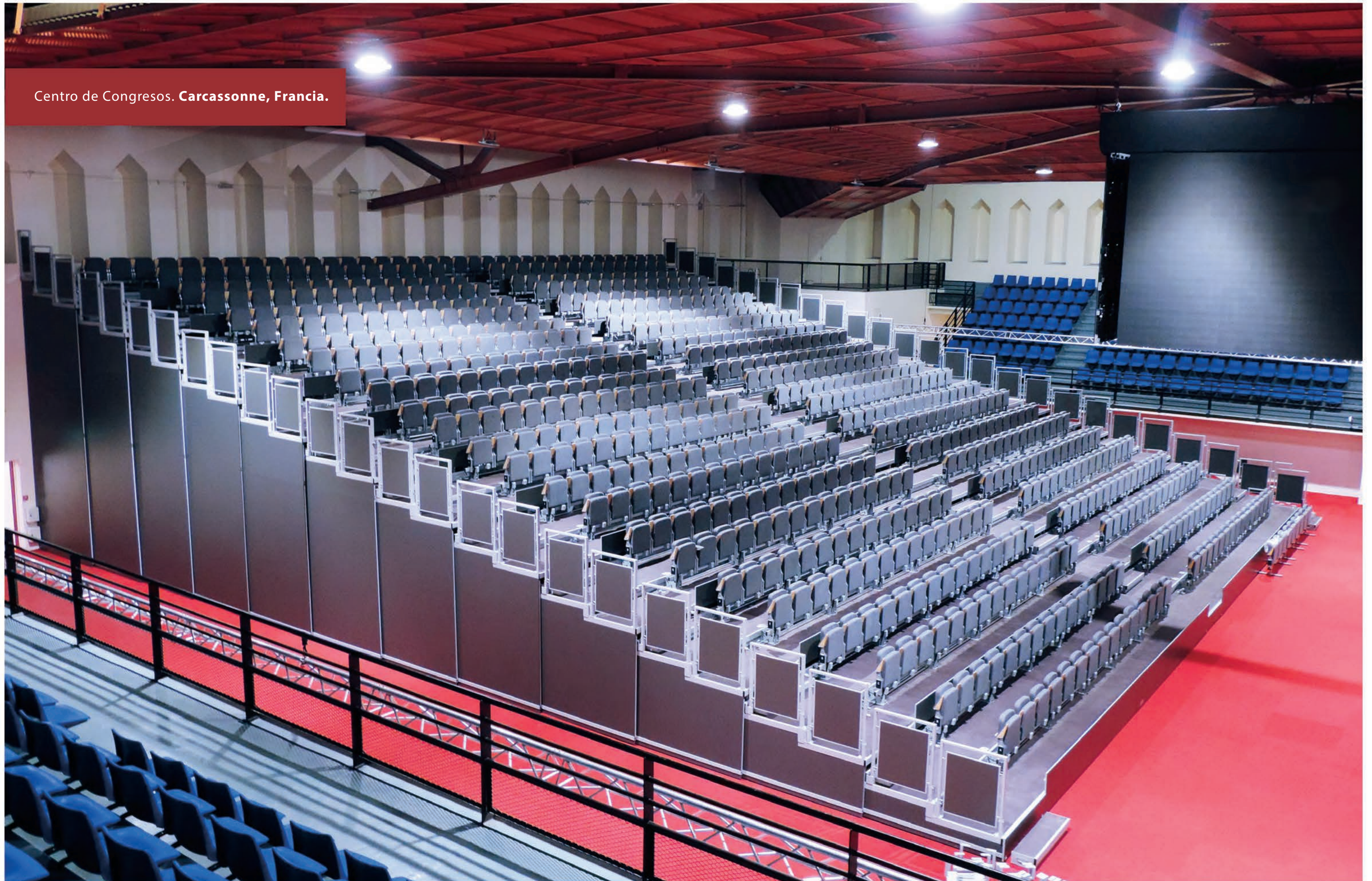



MOVABLE SEATS



Micra mobile seats are a concept of seat use but without the need for a fixed installation. They are made in groups which allows a quick installation as well as storage and transport when not in use.

The mobile seating main advantage in front of chairs is that by their design, the user cannot move them individually, being ordered and allowing homogeneity in the room, even at the time of evacuation.

Las butacas Micra móvil son un concepto de utilización de butacas pero sin la necesidad de una instalación fija. Se realizan en grupos lo que permite su rápida instalación así como su guardado y transporte cuando no se usan.

La ventaja principal de las butacas móviles frente a las sillas, es que por su diseño, el usuario no puede desplazarlas de forma individual, quedando ordenadas y permitiendo homogeneidad en la sala aún en el momento de la evacuación.

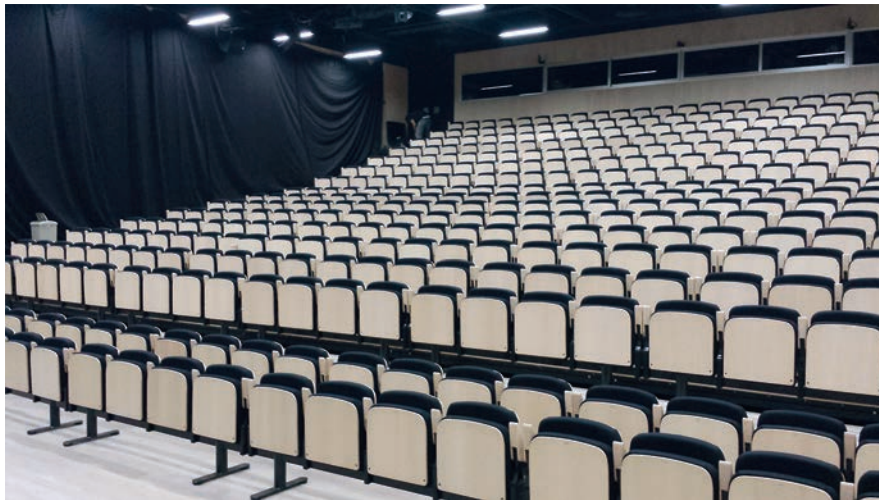
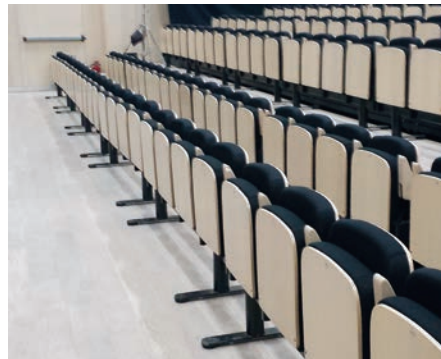

EUROSEATING Reserves the right to modify the seat specifications without notice. / EUROSEATING Se reserva el derecho de modificar las características sin previo aviso.

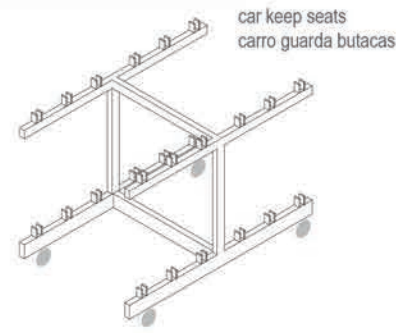
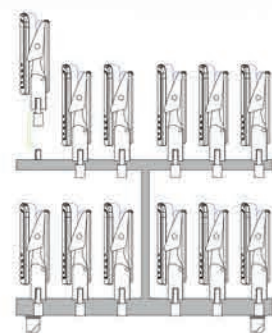
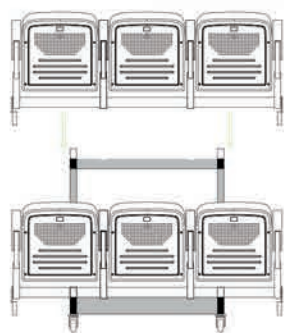

FLEXING SYSTEM

The Flexing system consists of the smooth complete folding of the 90° armchair. This format is widely used for telescopic bleachers and under-floor concealment since it allows the armchair to be horizontal, occupying a minimum space.

This system is available both for manual and automatic abatement.

El sistema Flexing consiste en el suave abatimiento completo de la butaca 90°. Este formato es muy utilizado para graderíos telescópicos y ocultación bajo suelo ya que permite a la butaca quedar en formato horizontal, ocupando un espacio mínimo.

Este sistema está disponible tanto para abatimiento manual como para abatimiento automático.



RETRACTABLE SEATING

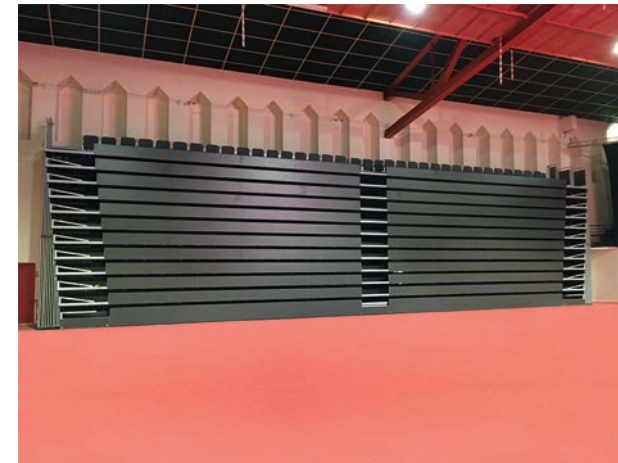

The grandstands or telescopic bleachers are systems designed to equip multipurpose rooms of different types of scenarios with an audience that appears or can be removed in just a few minutes.

Las tribunas o graderíos telescópicos son sistemas diseñados para dotar a salas polivalentes de distintos tipos de escenarios con un auditorio que aparece o se puede retirar en apenas unos minutos.

The seats of the Micra series were specially designed to adapt to any type of bleachers and telescopic bleachers, both with automatic folding system, manual, in configuration on "folder" type as well as mobile. Euro Seating offers seats for telescopic bleachers, as well as customized telescopic stands, operated manually or automated according to the needs of the project.

Las butacas de la serie Micra se diseñaron especialmente para adaptarse a cualquier tipo de tribunas y graderíos telescópicos, tanto con sistema de abatimiento automático, manual, en configuración sobre grada tipo "folder" así como móvil. Euro Seating ofrece tanto butacas para tribunas telescópicas, como soluciones de tribunas telescópicas a su medida, operadas de forma manual o automatizada según las necesidades del proyecto.

EUROSEATING Reserves the right to modify the seat specifications without notice. / EUROSEATING Se reserva el derecho de modificar las características sin previo aviso.





SPIROLIFT SYSTEM

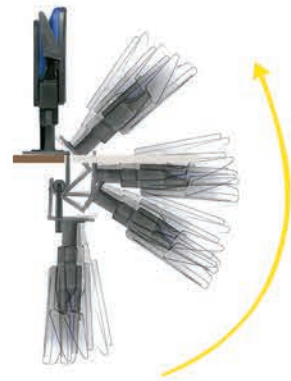
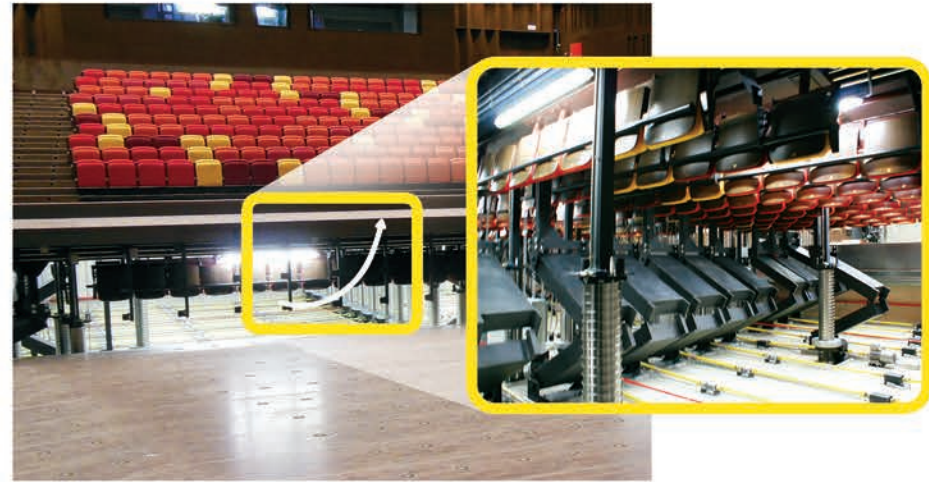

This innovative and sophisticated system allows its use in multifunctional rooms and the use of space in a very practical way with multiple floor formats:

horizontal, bleachers, pits, different levels, etc. with the provision of optimal seats at all times or the total concealment of them. When they are not required, the seats are under the floor by means of a full 180° automatic turn.

Este innovador y sofisticado sistema permite su uso en salas multifuncionales y el aprovechamiento del espacio de manera muy práctica con múltiples formatos de suelo:

horizontal, gradas, fosos, diferentes niveles, etc. con la disposición de butacas óptima en cada momento o la total ocultación de las mismas. Cuando no se requieren, las butacas quedan bajo el suelo mediante un giro automático completo de 180°.



EUROSEATING Reserves the right to modify the seat specifications without notice.
EUROSEATING Se reserva el derecho de modificar las características sin previo aviso.



RAILING SYSTEM

Micra seats on rails consist of seats under guide system that are previously installed on the floor of the project (and when they are not used are hidden) in which they move the Micra seats automatically or manually to their selected position.

When you wish to remove them, these seats can be moved until they are hidden in the area under the stage, the false wall or in another pre-selected location for that purpose. The model of armchair used for this purpose allows for its design an optimal use of space, leaving each row in its folding position occupying only 22 cm.

Las butacas Micra en rieles, consisten en butacas bajo sistema de guías que previamente se instalan en el suelo del proyecto (y que cuando no son usadas quedan ocultas) en las cuales se desplazan las butacas Micra de manera automática o manual hasta su posición seleccionada.

Cuando se desean retirar, estas butacas se desplazan hasta que quedan ocultas en zona debajo de escenario, en falsa pared o en otra locación antes preseleccionada. El modelo de butaca empleado para tal fin, permite por su diseño un óptimo aprovechamiento del espacio, quedando cada fila en su posición de plegado ocupando tan sólo 22 cm.

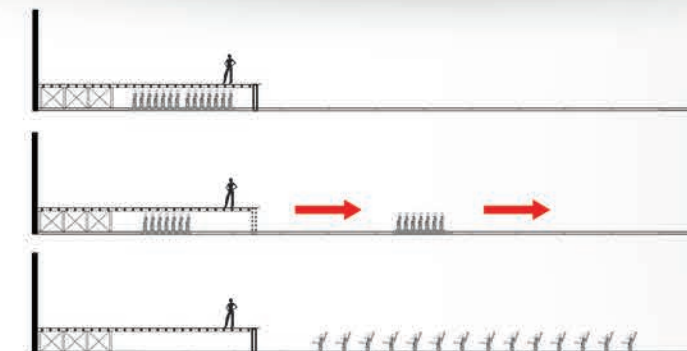

Falcon Club. Minsk, Bielorrusia.

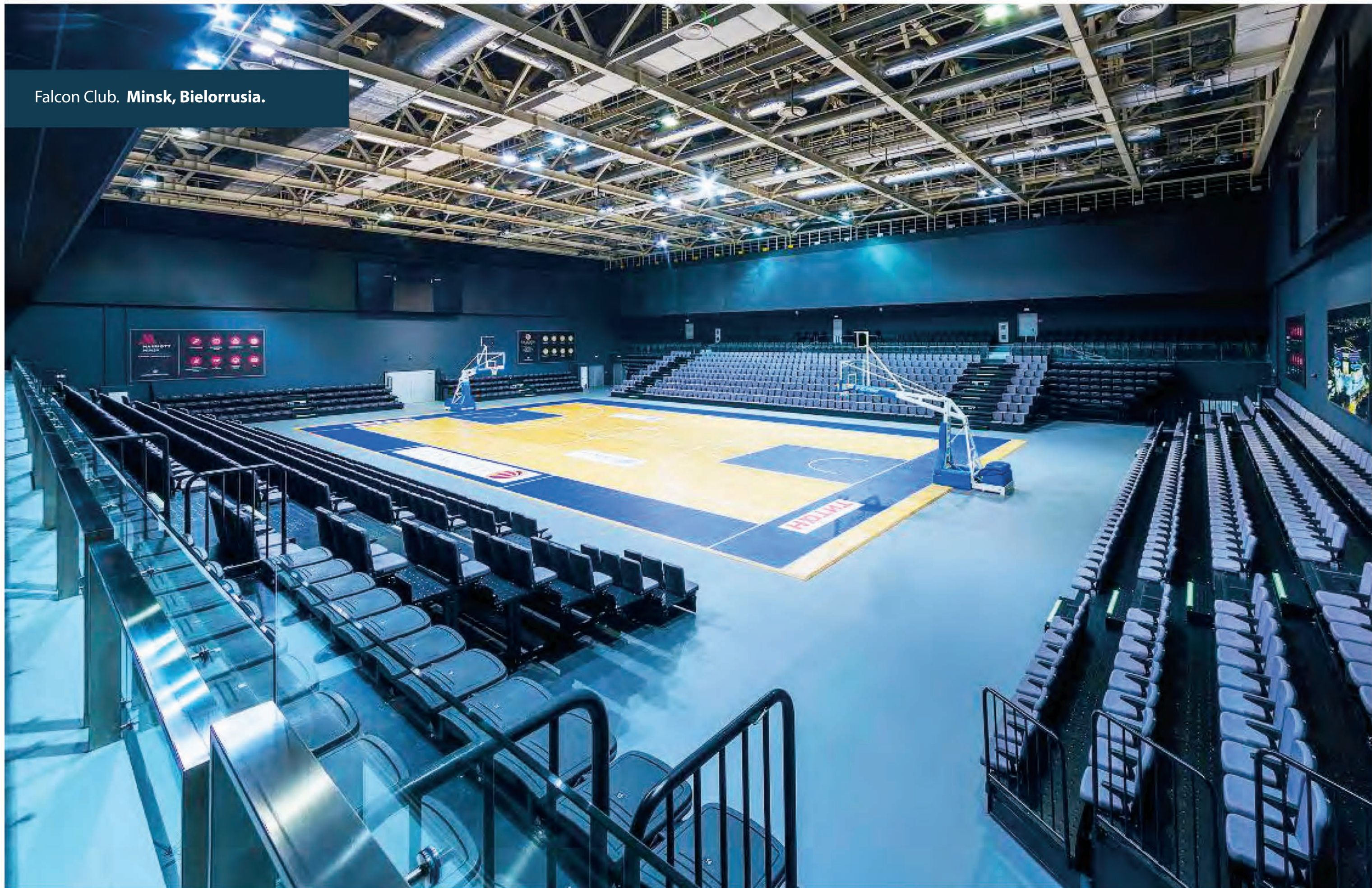

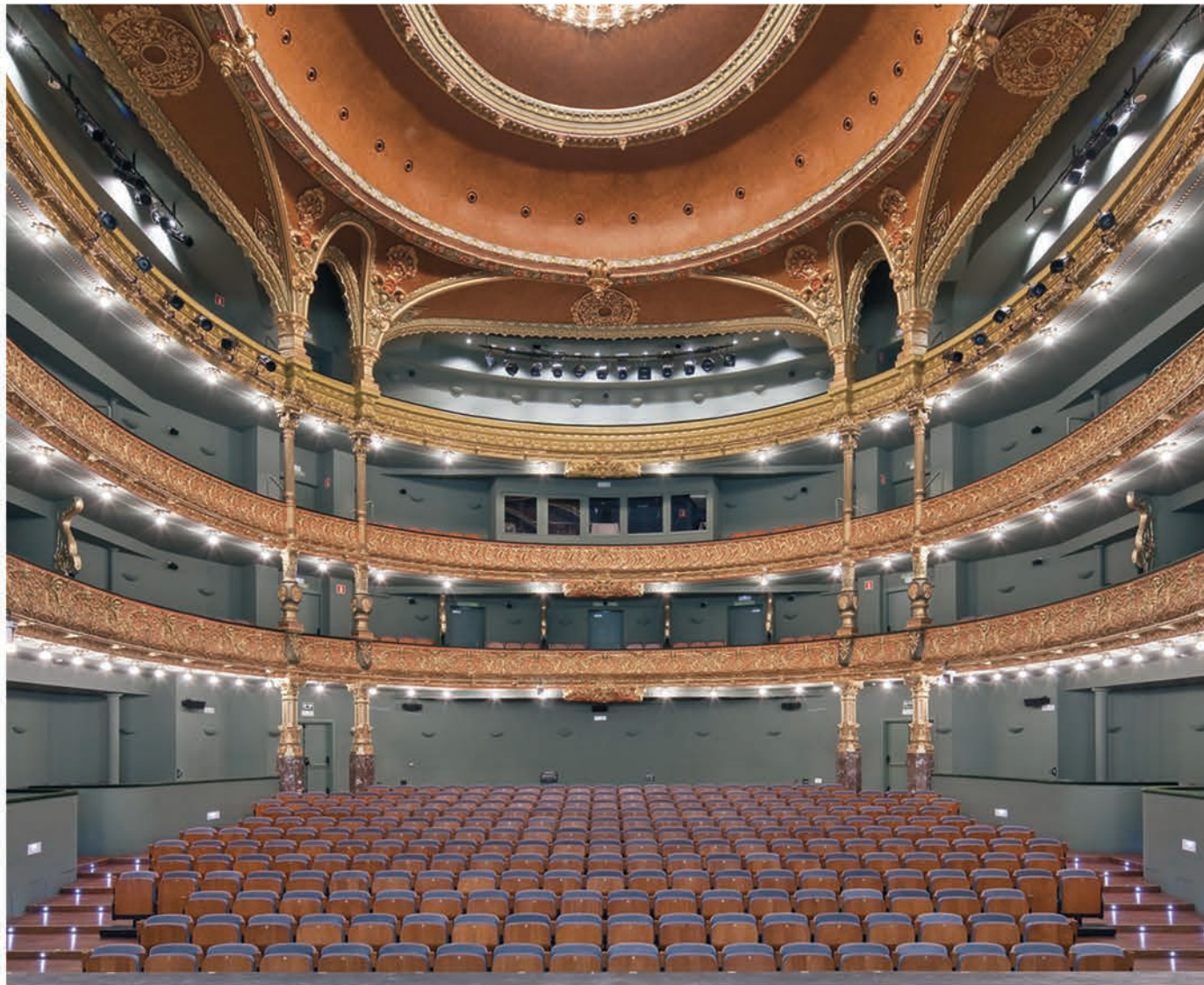
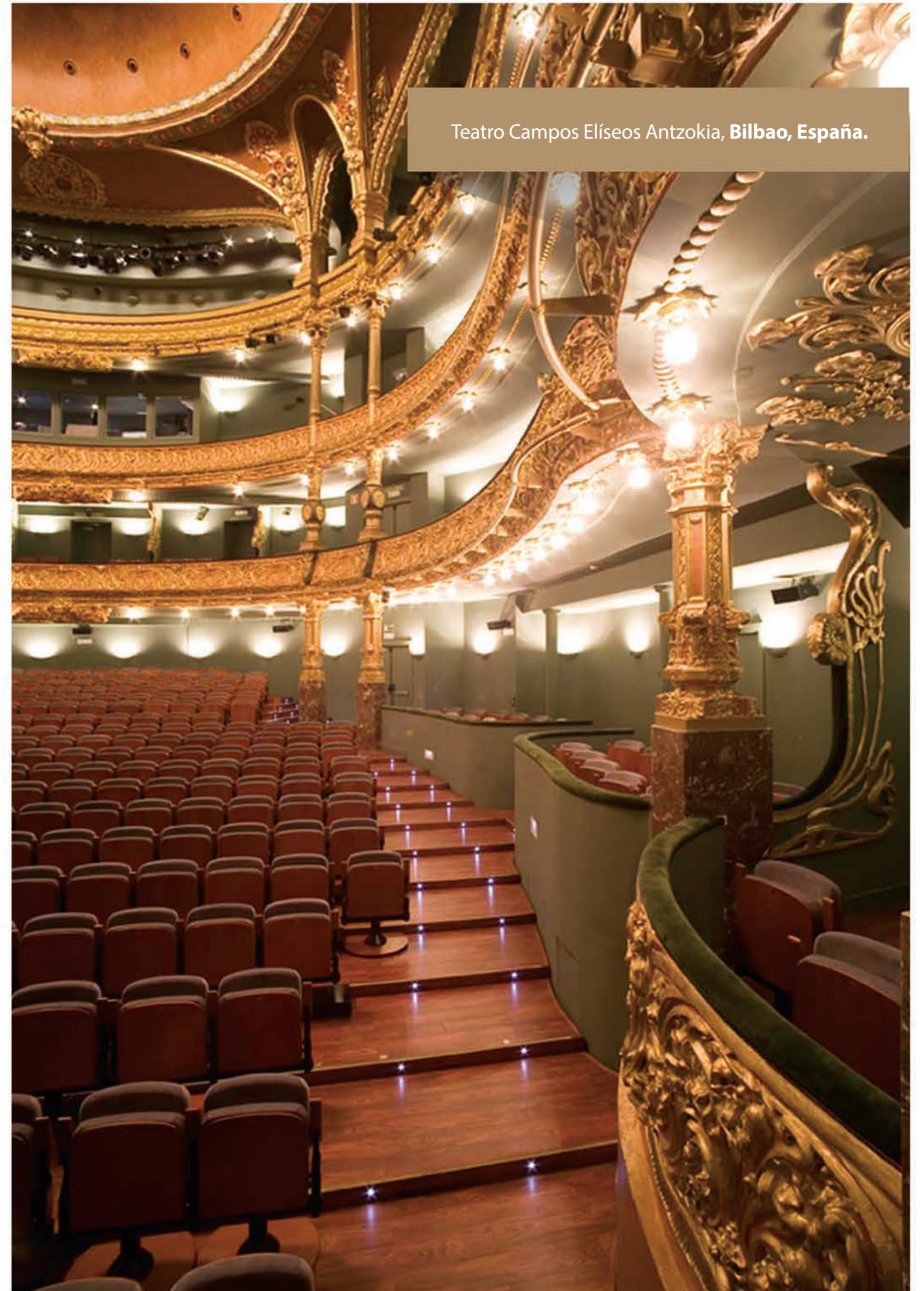



Universidad Centro. **CDMX, México.**

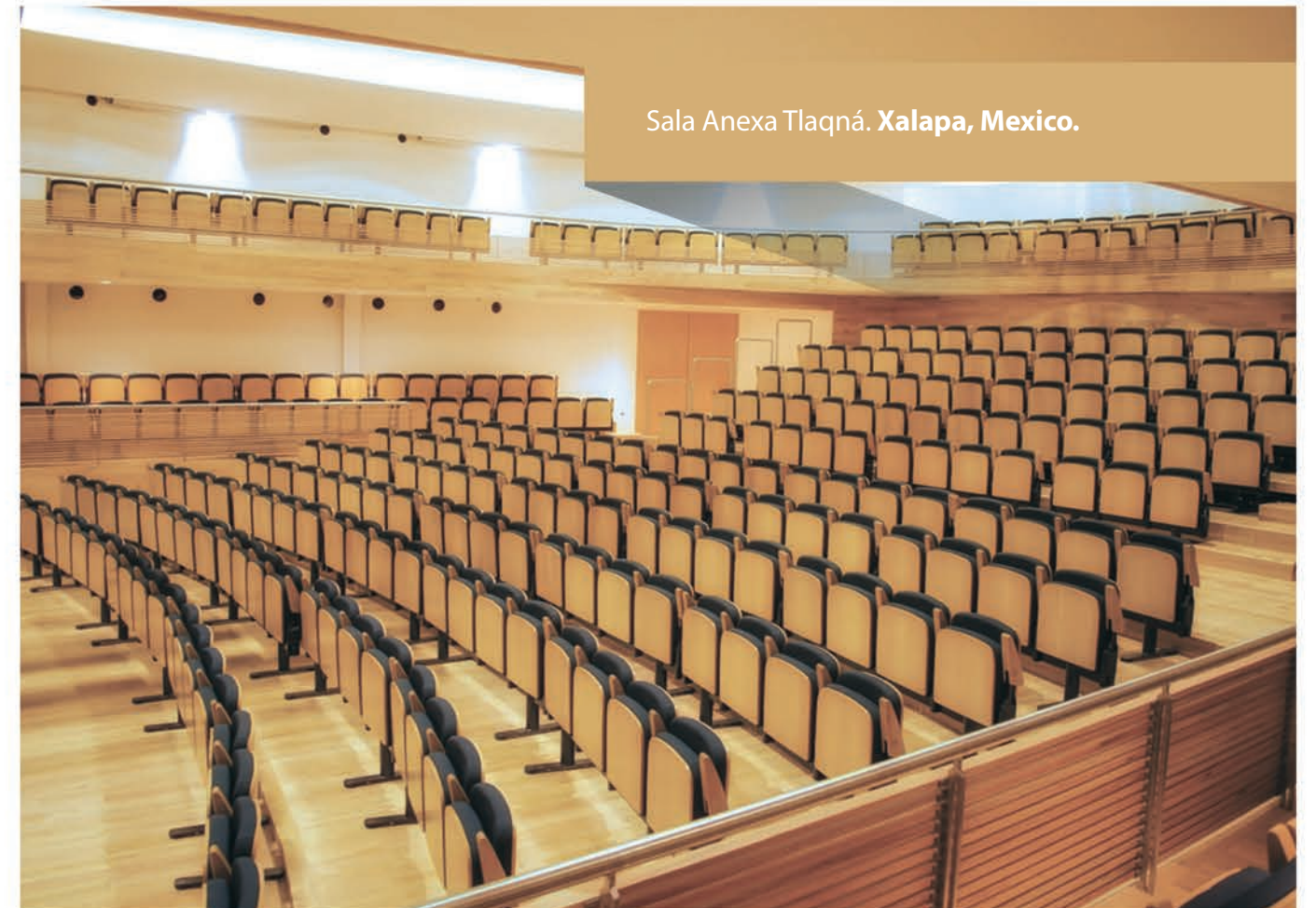

Sala Anexa Tlaqná. **Xalapa, Mexico.**

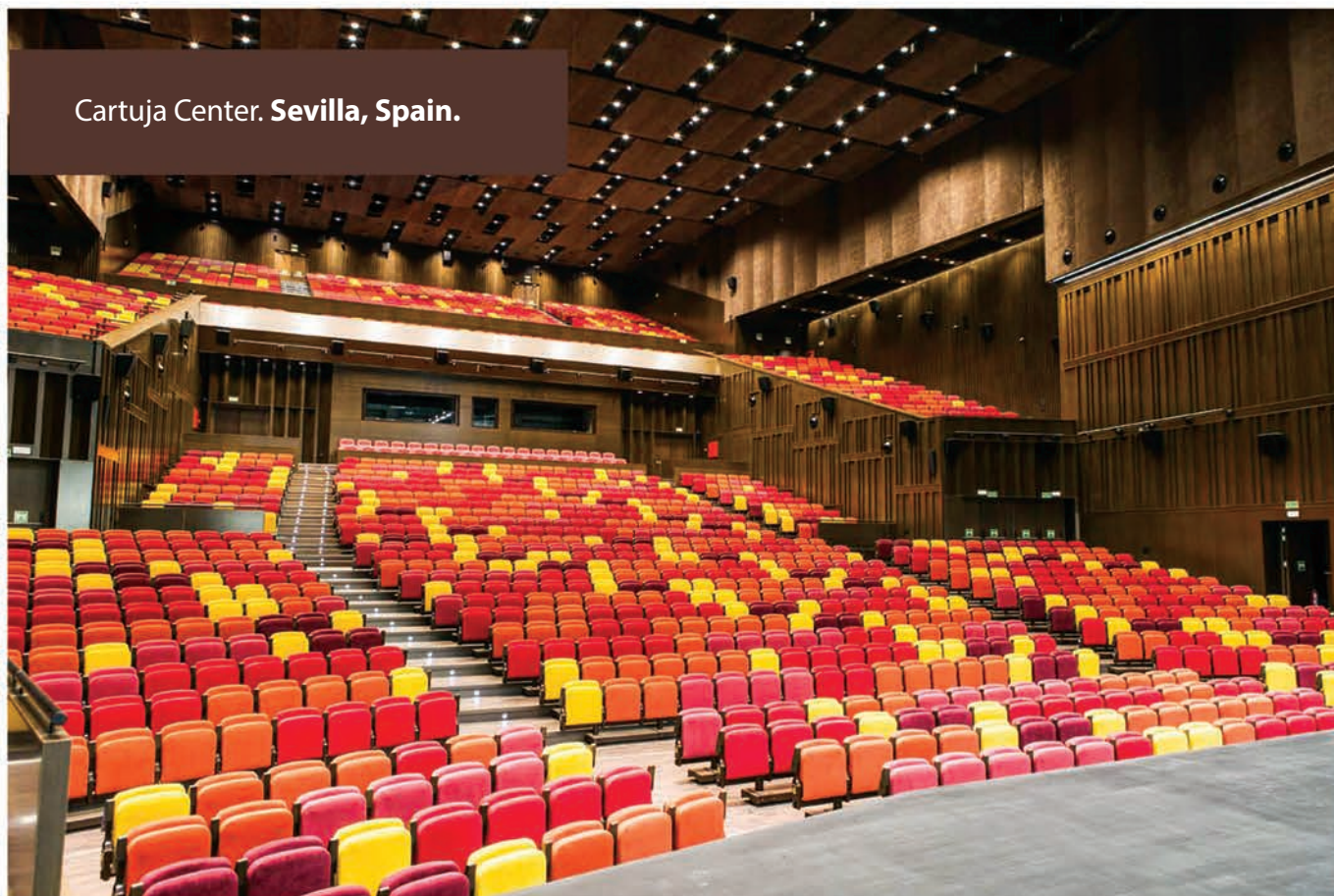

Cartuja Center. **Sevilla, Spain.**



Expo Colmar. **Colmar, Francia.**



Estadio Abanca-Riazor. A Coruña, España.



Colegio Oficial de Odontólogos. Madrid, España.



Estadio de Mestalla. Valencia, España.

